

pco.pixelfly usb

digital 14 bit CCD camera

resolution

1.4 megapixel

low noise

6 electrons



housing

ultra compact design

quantum efficiency

up to 62 %

short

interframing time

technical data

image sensor

type of sensor	CCD
image sensor	ICX285AL
resolution (h x v)	1392 x 1040 pixel (normal) 800 x 600 pixel (center ROI)
pixel size (h x v)	6.45 µm x 6.45 µm
sensor format / diagonal	2/3" / 11.14 mm
shutter mode	global (snapshot)
MTF	77.5 lp/mm (theoretical)
fullwell capacity	16 000 e ⁻ 24 000 e ⁻ (binning)
readout noise	5 .. 7 e ⁻ rms @ 12 MHz (typ.) 6 .. 8 e ⁻ rms @ 24 MHz (typ.)
dynamic range	2 667 : 1 (68 dB) 4 000 : 1 (72 dB, binning)
quantum efficiency	62 % @ peak
spectral range	290 nm .. 1100 nm
dark current	1 e ⁻ /pixel/s @ 23 °C
DSNU ¹	2 e ⁻ rms
PRNU ²	< 1 %

camera

max. frame rate	7.3 / 13.5 fps (12 / 24 MHz, normal) 11.7 / 21.6 fps (12 / 24 MHz, center)
exposure/shutter time	1 µs .. 60 s
dynamic range A/D	14 bit
A/D conversion factor	1.0 e ⁻ /count 1.5 e ⁻ /count
pixel scan rate	12 MHz / 24 MHz
pixel data rate	19.5 Mpixel/s
binning (hor x ver)	1 x 1 .. 4 x 4
non linearity	< 1 %
smear	< 0.002 %
anti-blooming factor	> 400 (standard 100 ms exposure) > 4 (NIR boost 100 ms exposure)
interframing time ³	1 µs (optional)
trigger input signals	software / TTL level
trigger output signals	3.3 V LVTTTL level
data interface	USB 2.0

¹ dark signal non-uniformity measured in a 90% center zone of the image sensor

² photo response non-uniformity

³ time between two consecutive images for particle image velocimetry (PIV) applications

general

power supply	9 .. 28 VDC (12 VDC typ.)
power consumption	< 4 W
weight	0.25 kg
operating temperature	+ 10 °C .. + 45 °C
operating humidity range	10 % .. 80 % (non-condensing)
storage temperature range	- 20 °C .. + 70 °C
optical interface	C-mount
CE certified	yes

frame rate table

resolution	normal	center	center	center
pixelclock [MHz]	12	24	12	24
1392 x 1040	7.3 fps	13.5 fps		
800 x 600			11.7 fps	21.6 fps
v2 binning	14.7 fps	27.0 fps	21.8 fps	40.4 fps
v4 binning	27.0 fps	47.0 fps	35.0 fps	62.0 fps

quantum efficiency

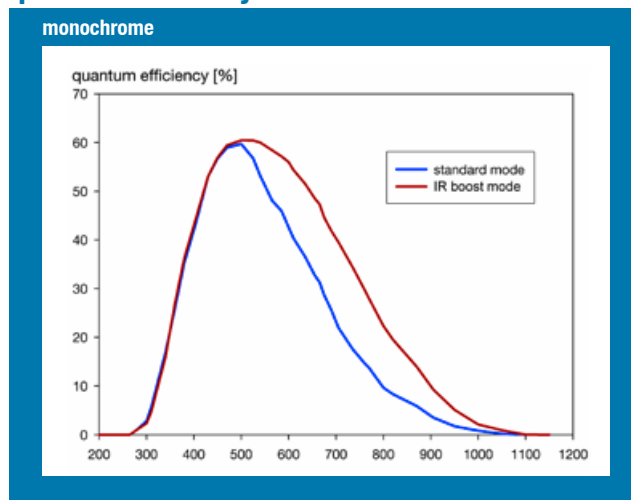

technical data

software

For camera control, image acquisition and archiving of images in various file formats PCO provides the software application Camware (Windows XP, 7 and 8).

A camera SDK (software development kit) including a 32 / 64 bit dynamic link library for user customization and integration on PC platforms is available for free.

For a list of third party software supported, please visit www.pco.de

options

monochrome & color versions available; custom made versions

dimensions

C-mount lens adapter

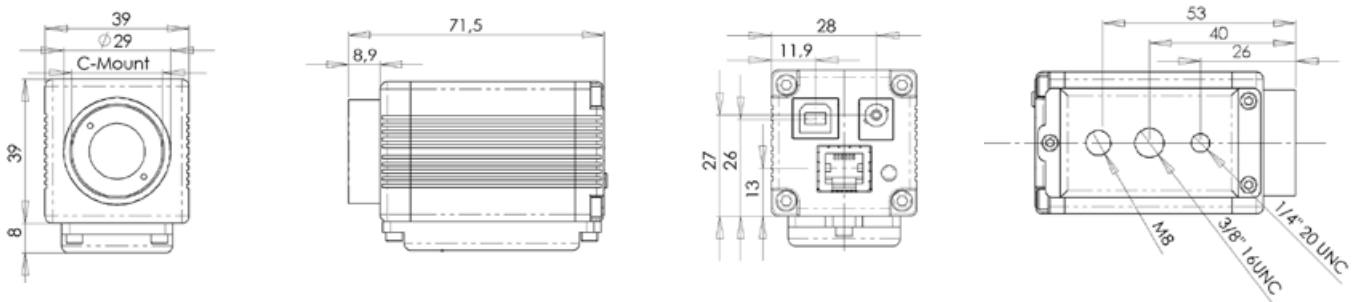

All dimensions are given in millimeter.

camera views

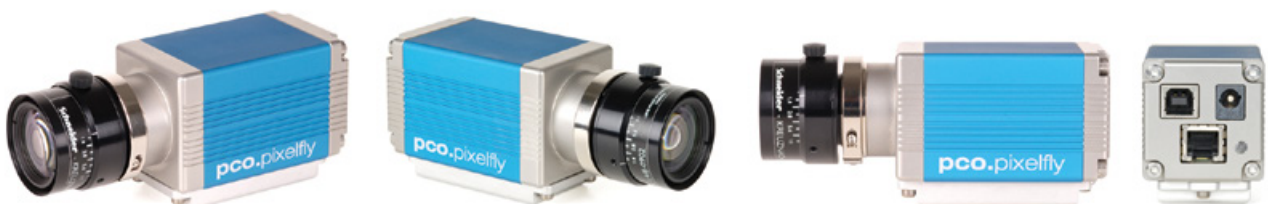

Further information can be found on www.pco.de



applications

bio marker

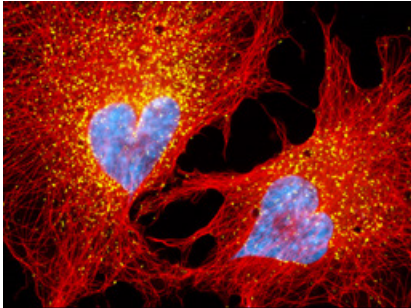

The high sensitivity and image quality are extremely useful characteristics for fluorescent multi-probe marker applications in microscopy.

quality control



View of a row of an empty bottle inspection system, which uses pixelfly cameras for the improved resolution inspection (IRIS), courtesy of Kronen AG, Neutraubling, Germany

combustion analysis

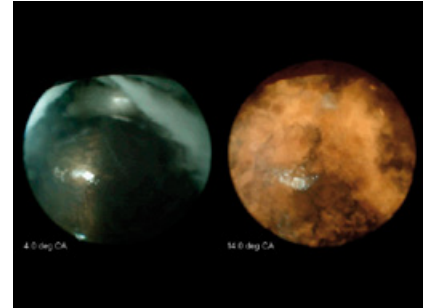

An endoscopic view in the combustion chamber of a Diesel engine. The two images show the injection and combustion of Diesel fuel. They were recorded at different Crank angles with the AVL VisioScope system, courtesy of AVL List GmbH, Graz, Austria

electron spectroscopy

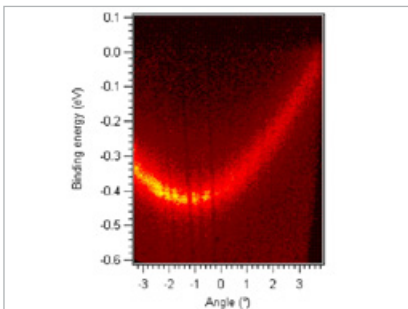

Cu (111) state dispersion image by a pco.pixelfly, courtesy of Specs GmbH - Surface Analysis and Computer Technology, Berlin, Germany

microscopy

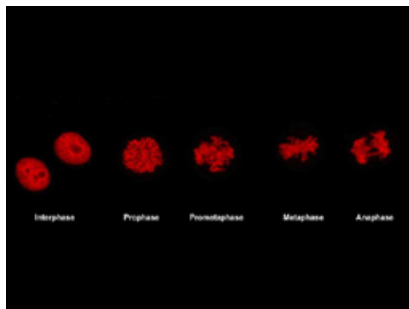

Human cervical carcinoma epithelial cells (HeLa) stained with mCherry Fluorescent Protein Histone H2B, recorded with a pco.pixelfly, the Cooke corporation

strain field

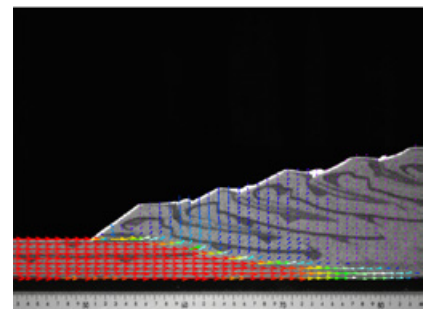

In the above experiment the motion of the different quartz sand layers was measured by a strainmaster system (incorporating pco.pixelfly cameras) and the strain field was computed, courtesy of LaVision, Göttingen, Germany

application areas

■ scientific imaging ■ low light level imaging ■ combustion imaging ■ high resolution microscopy ■ machine vision ■ industrial applications ■ particle image velocimetry (PIV) ■ spectroscopy ■ flow visualization (hydrodynamics) ■ industrial oem applications ■ fuel injection ■ material testing ■ luminescence spectroscopy ■ Red and NIR fluorescence applications ■ imaging of bio-markers (e.g. green fluorescent protein) ■ scintillation recording

europa

PCO AG
Donaupark 11
93309 Kelheim, Germany

fon +49 (0)9441 2005 50
fax +49 (0)9441 2005 20
info@pco.de
www.pco.de

america

PCO-TECH Inc.
6930 Metroplex Drive
Romulus, Michigan 48174, USA

fon +1 (248) 276 8820
fax +1 (248) 276 8825
info@pco-tech.com
www.pco-tech.com

asia

PCO Imaging Asia Pte.
3 Temasek Ave
Centennial Tower, Level 34
Singapore, 039190

fon +65 6549 7054
fax +65 6549 7001
info@pco-imaging.com
www.pco-imaging.com